

2 1/2 YD GRAPPLE

Open	118.00 "	2997.2mm
Capacity	2 1/2 yd ³	1.91 m ³
Cylinder bore	3 1/2 "	89mm
Lock valve on cylinders	Excluded	
Cylinder max. pressure	5000 psi	345 bar
Weight (with rotation)	6200 lb	2812 kg

200 SERIES DANGLING ROTATOR

Rotation	Unlimited	
Max axial load	200 000 lbs	90 718 kg
Rotation max. pressure	1 450 psi	100 bar
Torque at max. pressure	52 500 lb-in	5 931 Nm
Rotator flow	8-10 gpm	30-40 l/min
Rotation speed	15 rpm	
Weight	775 lb	352 kg

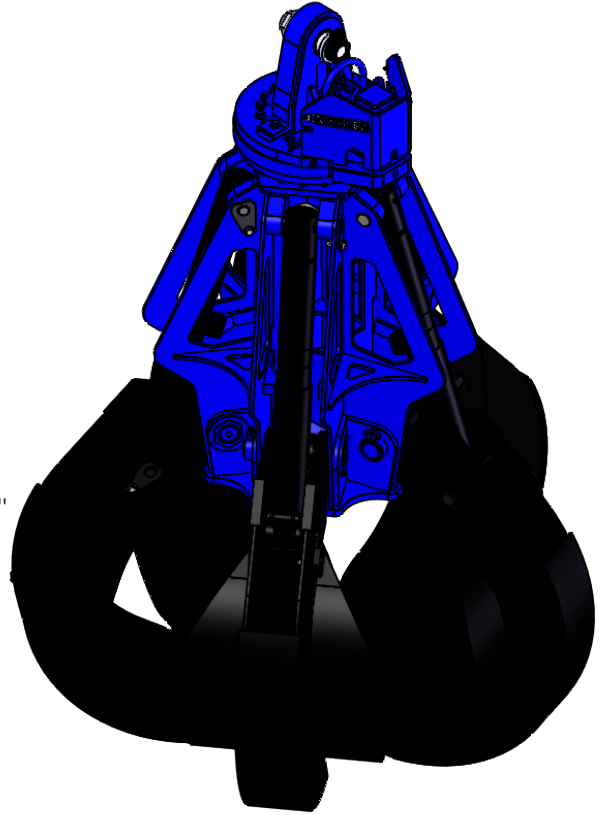
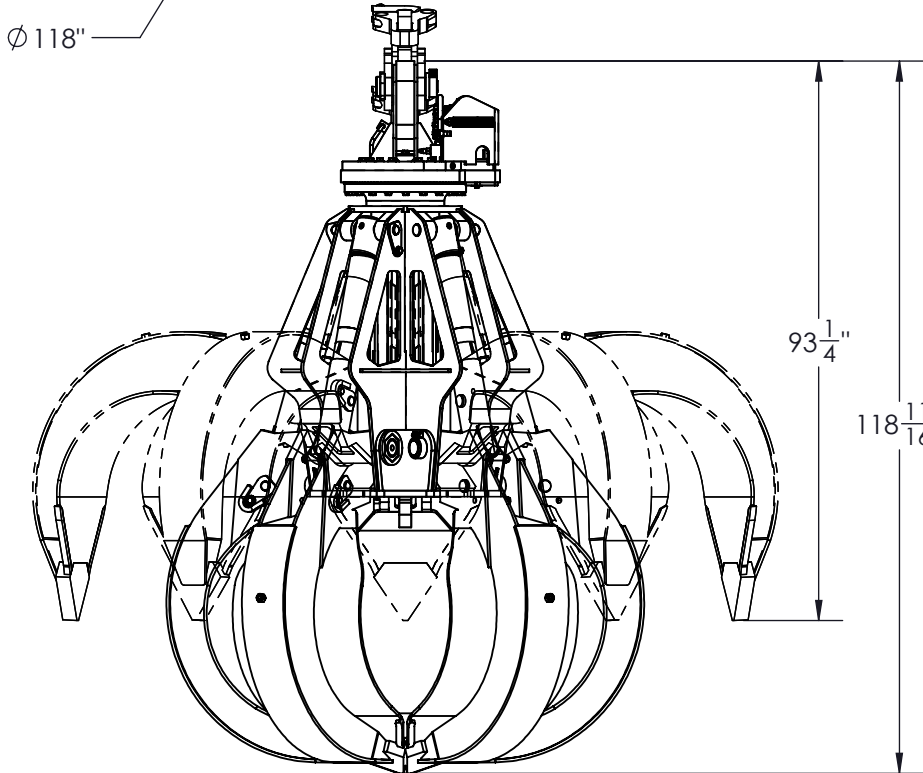

BATEMAN MANUFACTURING
 5 WINSTAR ROAD
 ORO-MEDONTE, ONTARIO
 L0L 2L0, CANADA

WWW.BATEMANMANUFACTURING.COM
MAIL@BATEMANMANUFACTURING.COM
 PHONE: (705) 487-5020
 FAX: (705) 487-5290

